

JVC
NIVICO



MODEL MCM-105E/5111
SOLID STATE POWER AMPLIFIER

Model MCM-105E/5111 Power Amplifier is one of the professional quality components of the 105E Series recently introduced by JVC. Other entries include Model MCT-105E/5108 AM/FM Stereo Tuner, Model MCA-105E/5107 Integrated Amplifier, Model MCP-105E/5110 Preamplifier and Model CF-105E/5109 Channel Filter. All components in this series have two important things in common: a precision, professional appearance utilizing refined black panels, and substantially upgraded performance. Model MCT-105E/5108 features a crystal filter which offers exceptional selectivity, an IC filter which virtually eliminates the unpleasant carrier leakage, and in general pulls in distant AM and FM broadcasts with a minimum of distortion. Both Models MCP-105E/5110 and MCA-105E/5107 feature

a pink noise generator and a seven-zone S.E.A. system that has recently captivated so many audiophiles the world over. Model MCP-105E/5110 in addition, employs a PNP-NPN hybrid direct-coupled 3-stage design, resulting in exceptional stability of the bias and a wide dynamic range. Model CF-105E/5109 offers a total of 36 combinations of crossover frequencies, and also boasts an S.E.A. type low booster. The 105E Series is just one of the many ways JVC allows every music lover throughout the world to build a high-performance stereo setup to meet his budget and quality requirements. It is also one of the many ways to greater stereo enjoyment. For there are always JVC components available to upgrade his stereo installation to a higher performance level.



NAMES OF PARTS

FRONT PANEL

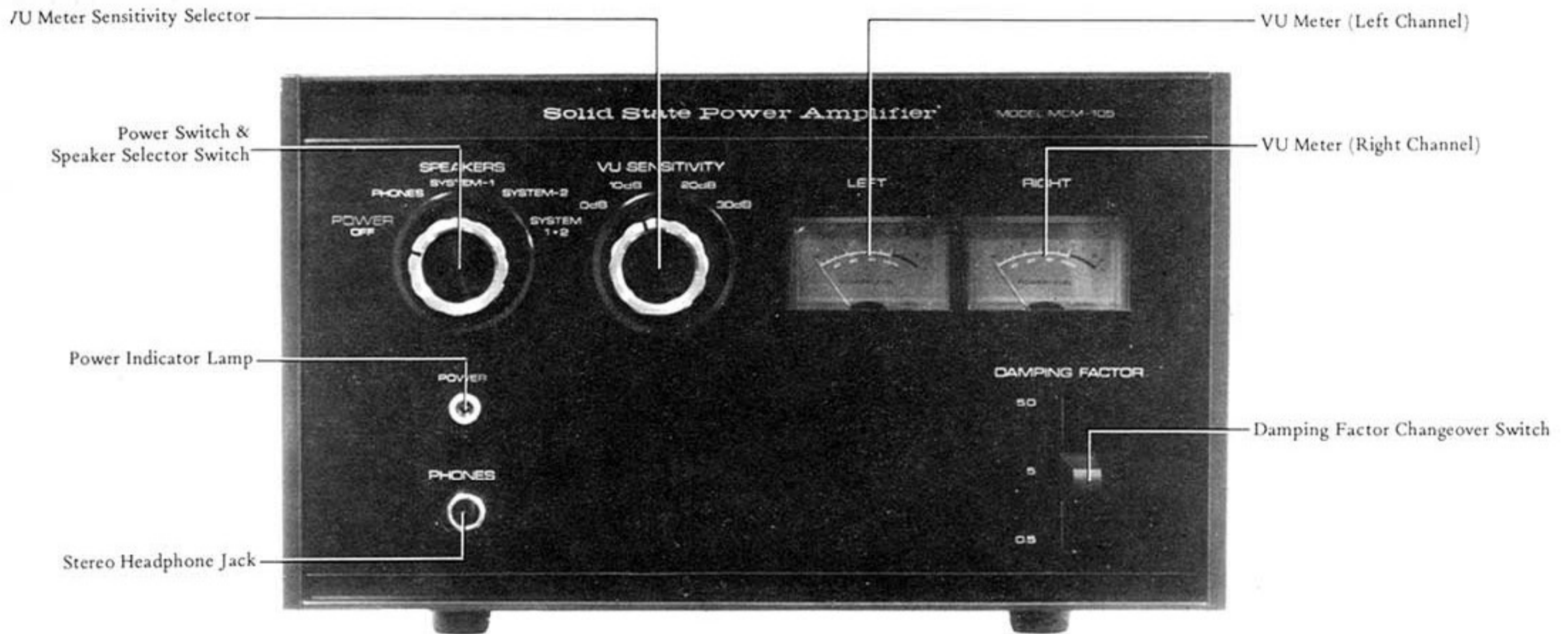

REAR PANEL

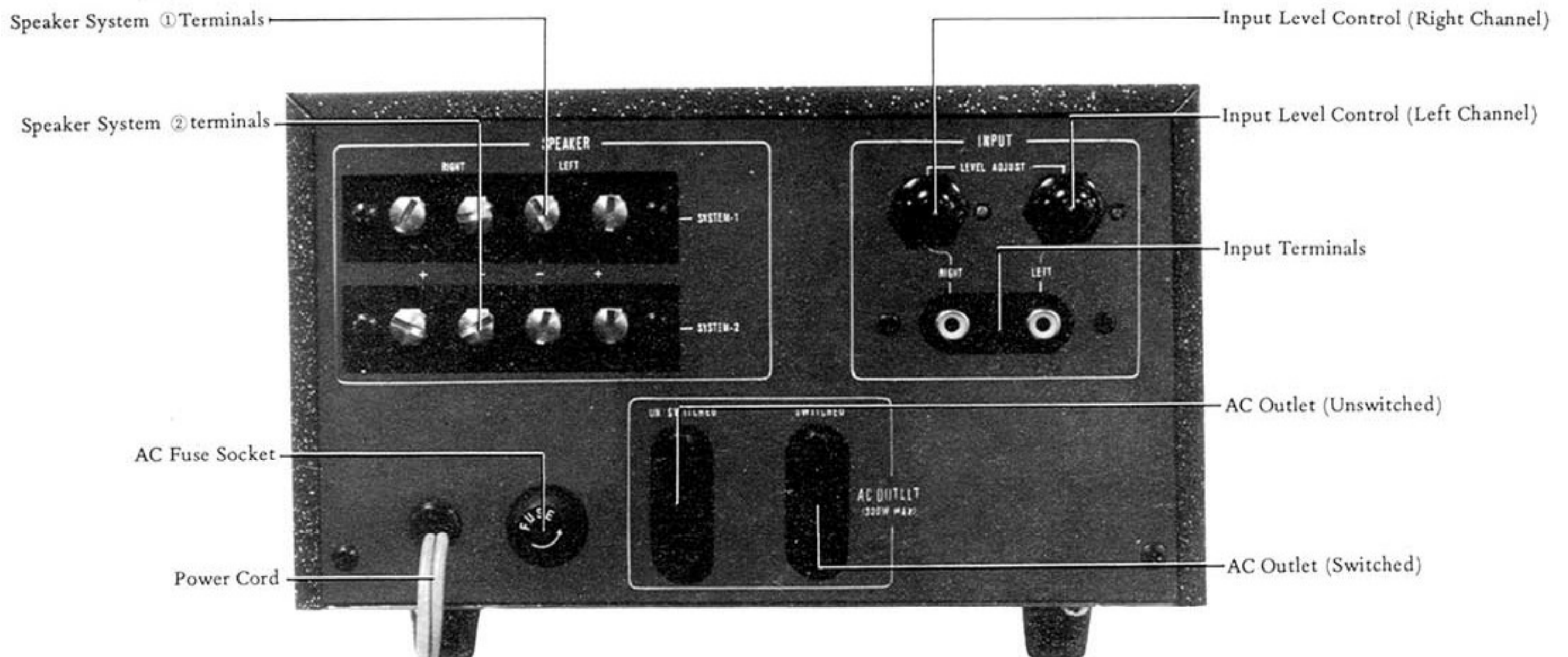

FRONT PANEL

1. Speaker Terminals (SYSTEM-1, SYSTEM-2)

Connect speakers with an impedance of $4\ \Omega$ to $16\ \Omega$ to these terminals. However, if the speaker impedance is $4\ \Omega$ and the amplifier output is raised to 50W, the built-in protection circuit may operate and the sound may become intermittent or completely absent. Two sets of speakers can be connected to the MCM-105E/5111, and operated either independently or simultaneously. However, as the built-in protection circuit will operate if the combined load impedance should go below $4\ \Omega$, it must be remembered not to connect $4\ \Omega$ speakers to both sets of speaker terminals if you ever wish to operate all four speakers simultaneously.

2. Power Indicator Lamp

When power is supplied to the amp, the power Indicator Lamp glows.

3. Headphone jack (PHONES)

Connect a pair of headphones (Models STH-2E and STH-10E available) to this jack, and set the Speaker selector knob to the Phones position. Then the speaker systems are off, and stereo music is enjoyed privately through the headphones. Note that when a multiple amplifier system is composed, not all the sound ranges are reproduced through this jack.

4. Meter sensitivity selector (VU SENSITIVITY)

With this selector set to the "0 dB" position, the VU meters indicate "0" when the amplifier output is 50 watts through an 8-ohm load. As the selector is set to "10 dB," "20 dB" and "30 dB," the meter sensitivity increases 10 dB respectively.

5. VU level meters

Indicate the output levels of left and right channels separately.

6 Damping factor switch (DAMPING FACTOR)

The damping factor is calculated by using the following formula:

$$DF = \frac{\text{Load impedance (speaker impedance)}}{\text{Internal impedance of amplifier}}$$

With a smaller damping factor, the transient characteristic of speaker is deteriorated, making softer tone quality. With a larger damping factor, the transient characteristic of speaker is improved, resulting in more crisp tone quality. With Model MCM-105E/5111 the damping factor is changeable in three steps. Set the Damping Factor switch to the 50, 5 or 0.5 position for desired tone quality.

- "50" Tone quality of transistor amplifier
- "5" Tone quality of triode amplifier
- "0.5" Tone quality of pentode amplifier

REAR PANEL

1. Speaker Terminals

Connect speakers with an impedance of $4\ \Omega$ to $16\ \Omega$ to these terminals. However, if the speaker impedance is $4\ \Omega$ and the amplifier output is raised to 50W, the built-in protection circuit may operate and the sound may become intermittent or completely absent. Two sets of speakers can be connected to the MCM-105E/5111 and operated either independently or simultaneously. However, as the built-in protection circuit will operate if the combined load impedance should go below $4\ \Omega$, it must be remembered not to connect $4\ \Omega$ speakers to both sets of speaker terminals if you ever wish to operate all four speakers simultaneously.

2. Input level controls (INPUT LEVEL ADJUST)

These controls adjust separately the levels of left and right channels at their input terminals. Adjust them according to the gain of the preamplifier connected. Each input level control is capped. The cap is removable by turning it counterclockwise.

3. Input jacks (LEFT-RIGHT)

Connect to these jacks the output of the preamplifier to be used with Model MCM-105E/5111. These terminals have the input sensitivity that gives the maximum output at an input of 0.8 volt (1 kHz).

4. AC fuse socket (FUSE)

The fuse socket contains an AC power fuse of 3.3 amperes (100~120V) or 1.8 amperes (200~240V). When the fuse blows out, disconnect the power cord from the outlet, and replace by the one of the same rating. Never use a copper wire or a fuse of greater rating, since such creates a fire hazard.

5. AC Outlets

These two AC outlets are each capable of supplying AC power. The above is controlled by the pow 50 Switch, but the lowest one is not. The combined maximum power capacity of the two outlets is 300W; this limit should be strictly observed when connecting external audio equipment.

6. AC Fuse Socket

Inside this socket is a 3.3A (AC 100~120V) or 1.8A (AC 200~240V) fuse to control the AC power supply to the amplifier.

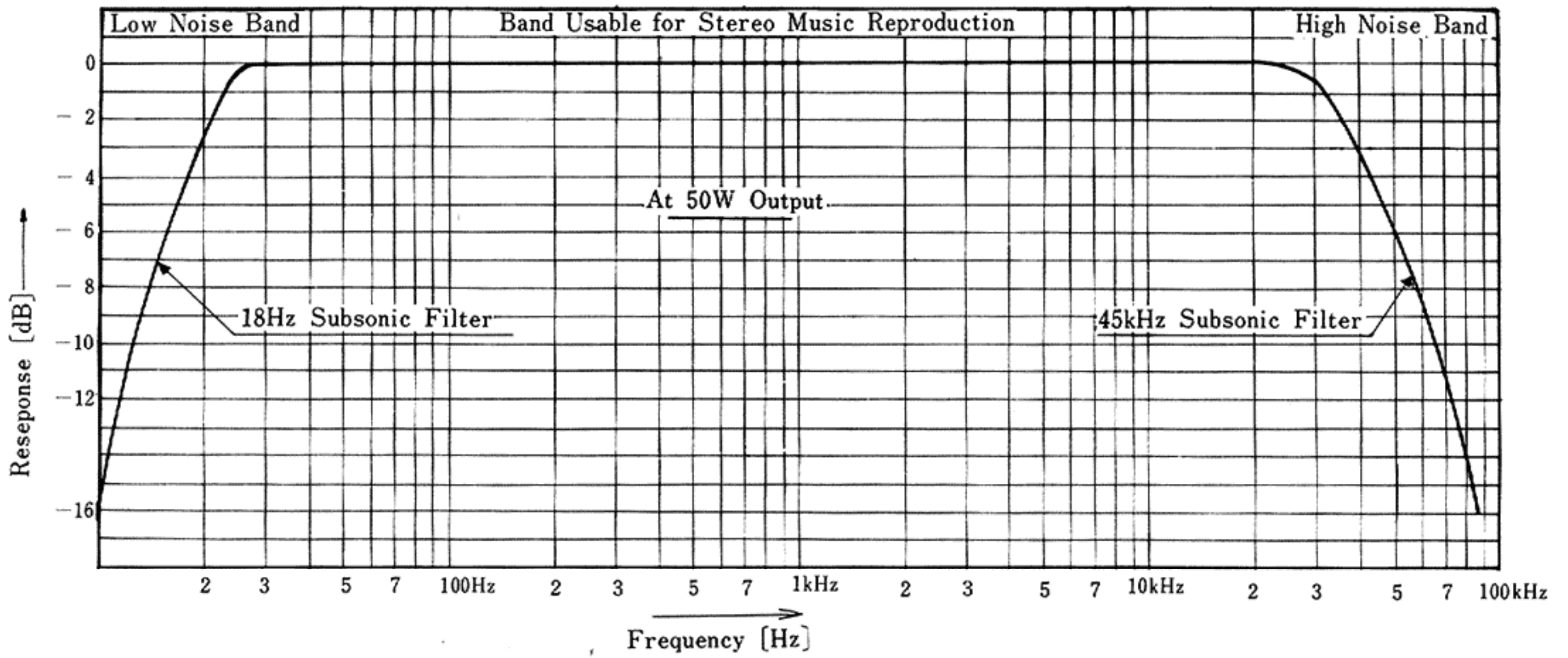

Frequency Characteristic (8 Ω load at 50W Output)

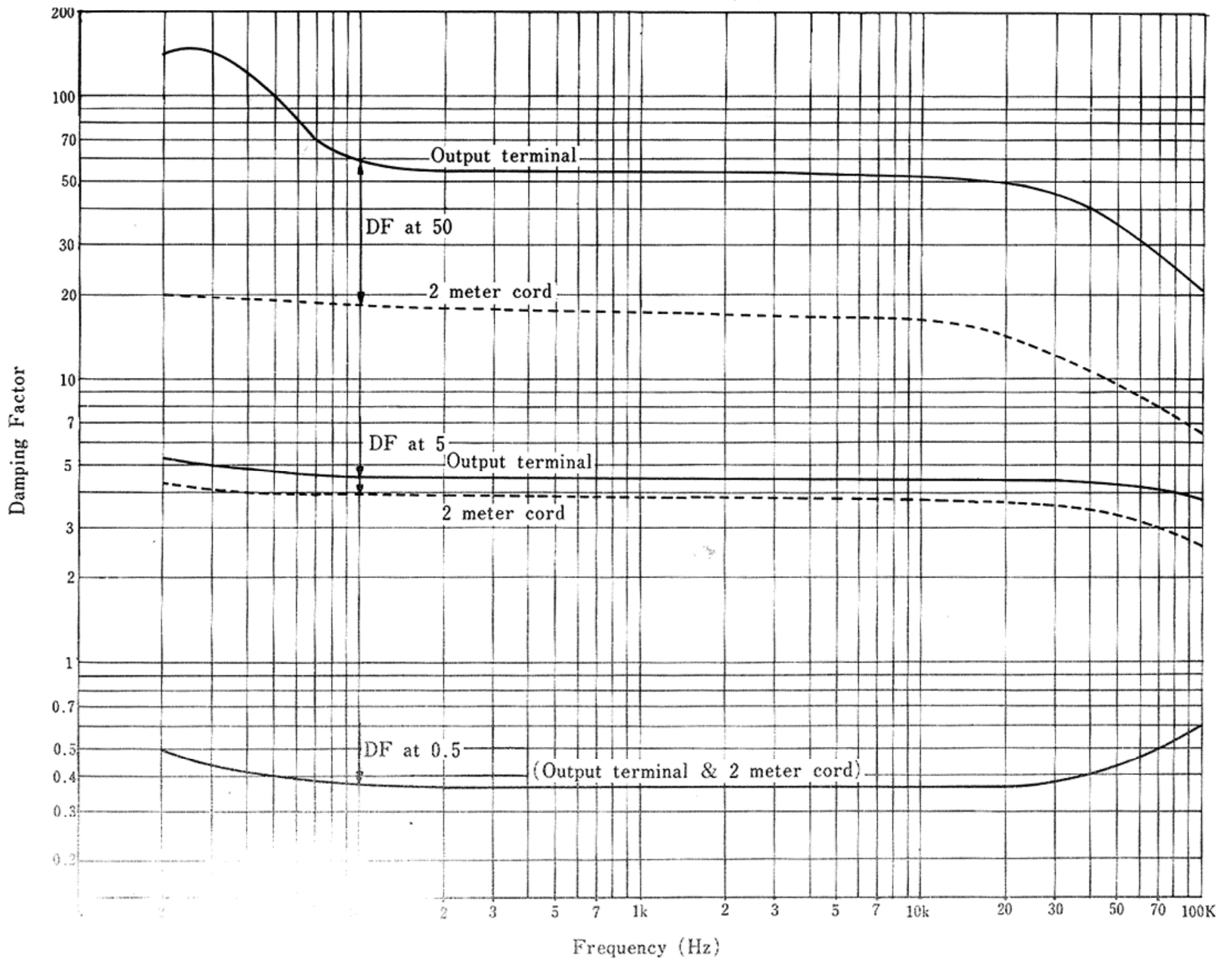

Frequency vs. Damping Factor Characteristic

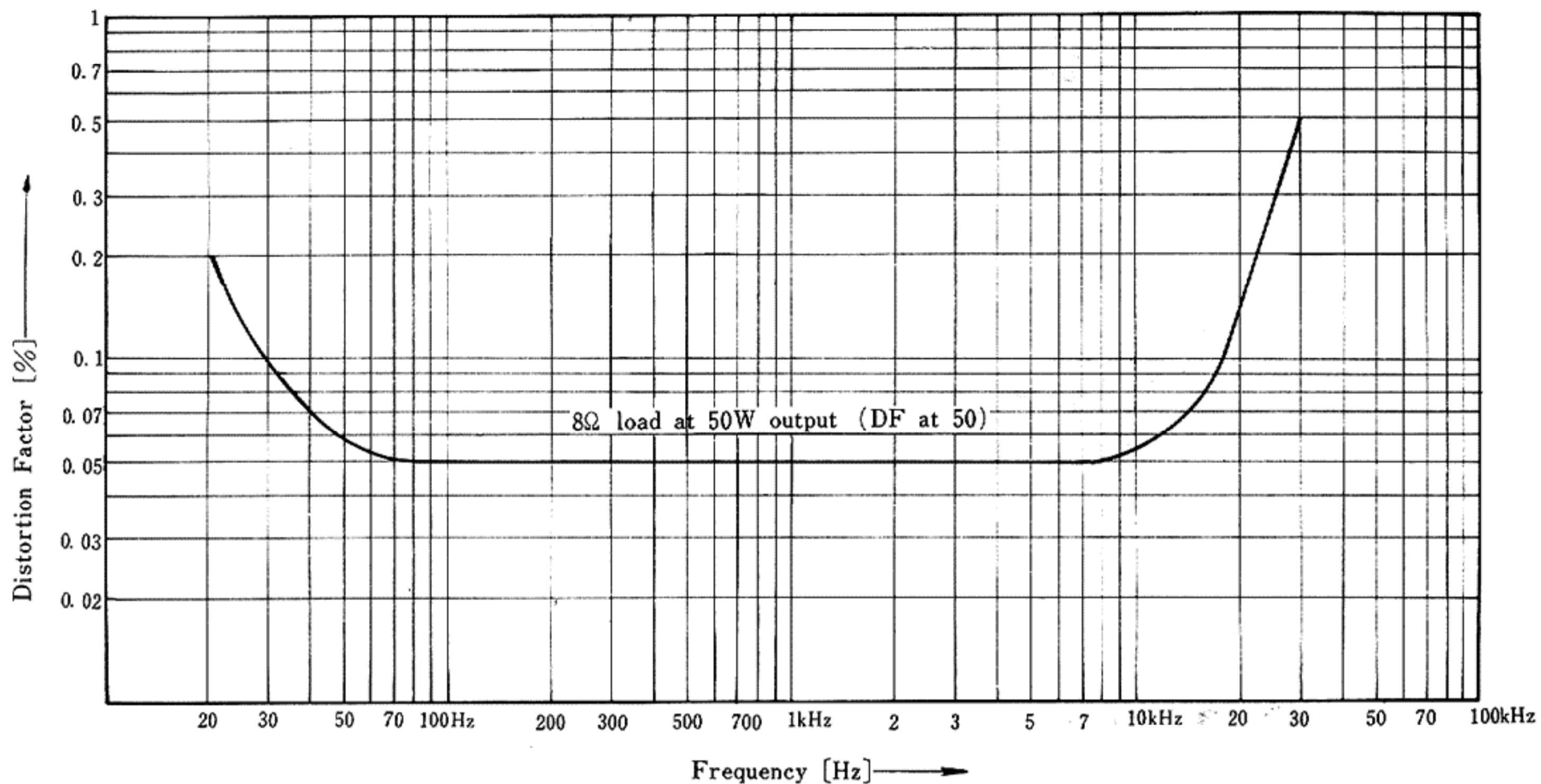

Frequency vs. Distortion Factor Characteristic (8 Ω load at 50 W Output)

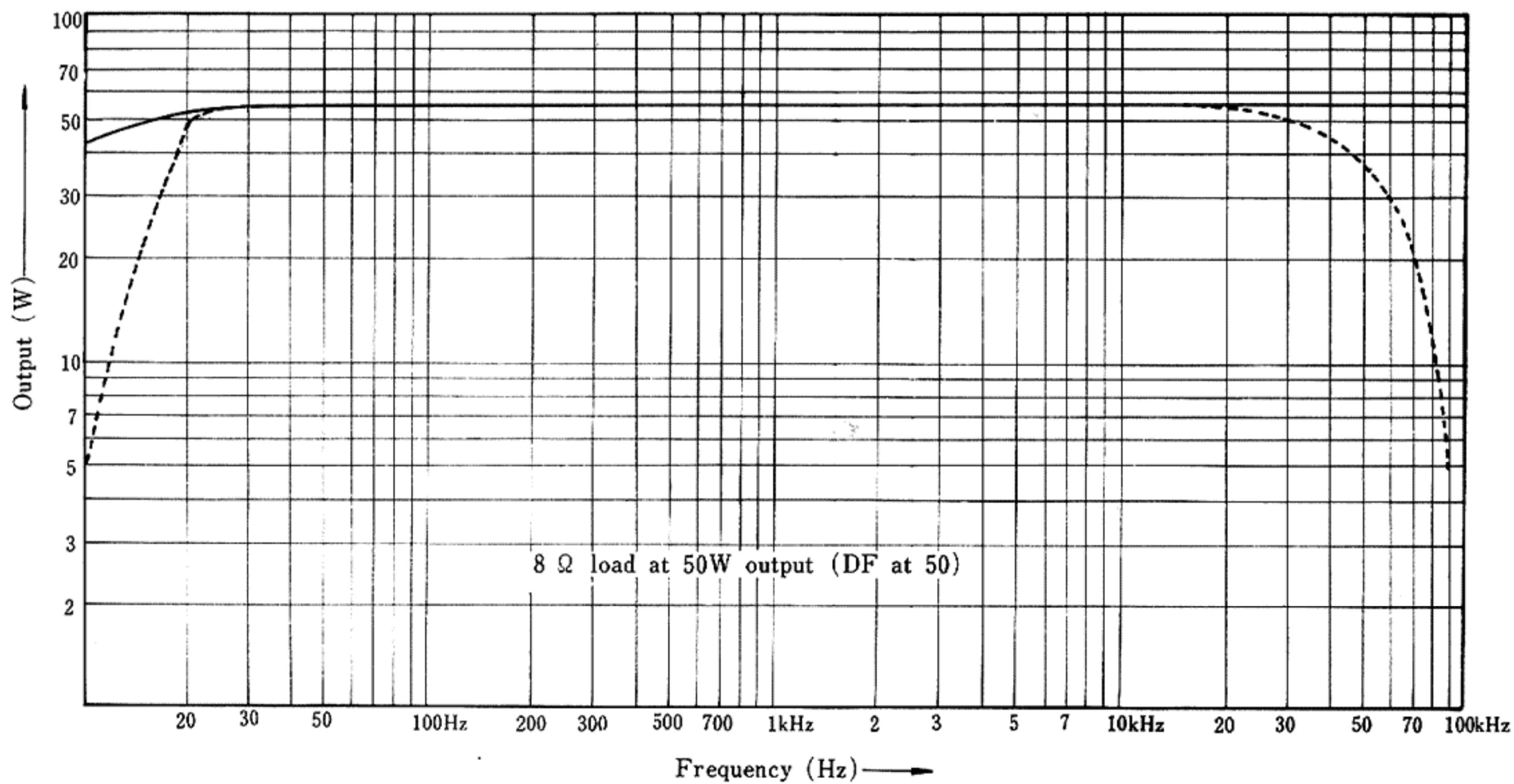

Power Bandwidth Characteristic
(8 Ω load at 50 W Output, Distortion Factor is constantly 0.5%)

MULTI AMPLIFIER SYSTEM

Speaker systems usually incorporate a crossover network. Located between the main amplifier and individual speakers, this network divides the audio frequency range into two or three bands for reproduction by the individual speakers. Hence the two-, three- and four-way classifications of speaker systems.

In a multi-amplifier stereo system, this crossover network is not necessary. Instead, a channel filter unit is placed after the preamplifier, dividing the audio frequency

range into several bands for amplification by separate main amplifiers. This means each main amplifier is required to amplify a much narrower frequency band, resulting in greatly reduced intermodulation distortion, better separation and clearer sound. Without the network between the main amplifiers and individual speakers, amplifier damping is considerably improved and the transient responses of the speakers are also noticeably bettered.

Rear Panel of JVC MCA-105E/5107 Integrated Amp.

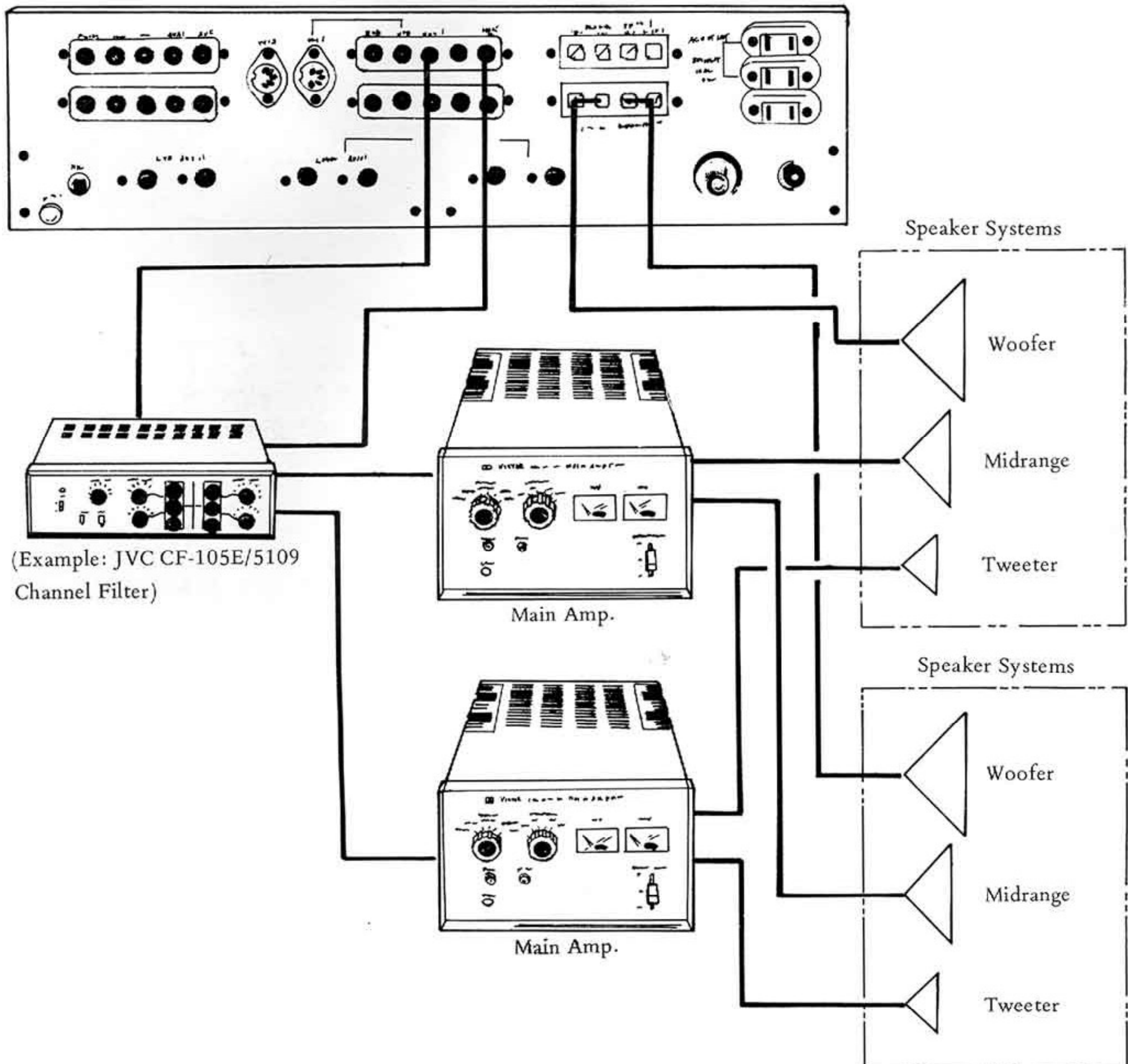

HINTS TO KEEP YOUR MCM-105E/5111 IN TOP CONDITION

- 1) The set is designed to operate on all AC line voltages and frequencies from 100 240V, 50 or 60 Hz. Before plugging in the power cord, make sure that the voltage indicated on the tag of the cord agrees with the voltage requirements of your area.
To select voltage, connect the voltage selecting plug at the left corner of the chassis, after making sure that the voltage indicated on the plug agrees with the voltage of your AC power requirements.
 - 2) Be sure that the power supply voltage stays within +10% of the voltage to which the amplifier is adjusted. If, for example, the amplifier is subjected to power of over 110V when its voltage changeover plug is set at 100V, the power transistors and other important parts may be seriously damaged.
 - 3) Operate the amplifier where the temperature is below 35°C (95°F) and humidity is less than 90%.
 - 4) If the amplifier is to be operated continuously over one hour at an output capacity of 8W or more per channel, be sure that there is nothing to obstruct the radiation of heat.
 - 5) When attempting to connect a phonograph, tuner and speaker systems, cut off the power supply to the amplifier first. Otherwise, loud click noise may damage the speakers.
 - 6) Be extra careful to make proper connections between the amplifier and external equipment such as speakers, a tuner, etc. If the polarities of speakers are connected conversely, speaker phase is reversed and the reproduced sound will lack the sense of direction. If the speaker terminals are shorted, the built-in protection circuit will operate, with the result that no sound will be heard.
- When connecting external equipment with pin plugs, be sure that the pin plugs are fully and completely inserted. If their grounding terminals are not securely inserted into the receiving jacks, the saturation output of hum may be added to the speakers and damage them.
- 7) You may sometimes hear abnormal click noise if you operate a switch or control within 5 to 6 seconds after turning on or off the amplifier. So it is usually advisable to wait until the amplifier stabilizes before setting out to operate switches and controls.
 - 8) When the load impedance connected to this amplifier goes below 4 Ω , the built-in protection circuit will automatically operate and sound may become intermittent. So if you have connected two sets of speaker systems and wish to operate all of them simultaneously by setting the Speaker Selector switch to "SYSTEM 1+2", be sure that the combined impedance of the speakers connected in parallel is 4 Ω or greater. In other words, if two sets of speaker systems are connected, each speaker system should have an impedance of at least 8 Ω .
 - 9) Should the built-in protection circuit operate for some reason and the sound become intermittent or completely absent, turn off the amplifier once and eliminate the cause. If there is nothing wrong with the amplifier itself, the protection circuit will automatically return to the normal state.
 - 10) Please do not touch the mechanical parts, electric circuitry or S.E.A. section.
 - 11) Turning the power switch on keeps you wait for 10 seconds for the purpose of protecting the speakers from damage.

CHARACTERISTIC GRAPHS

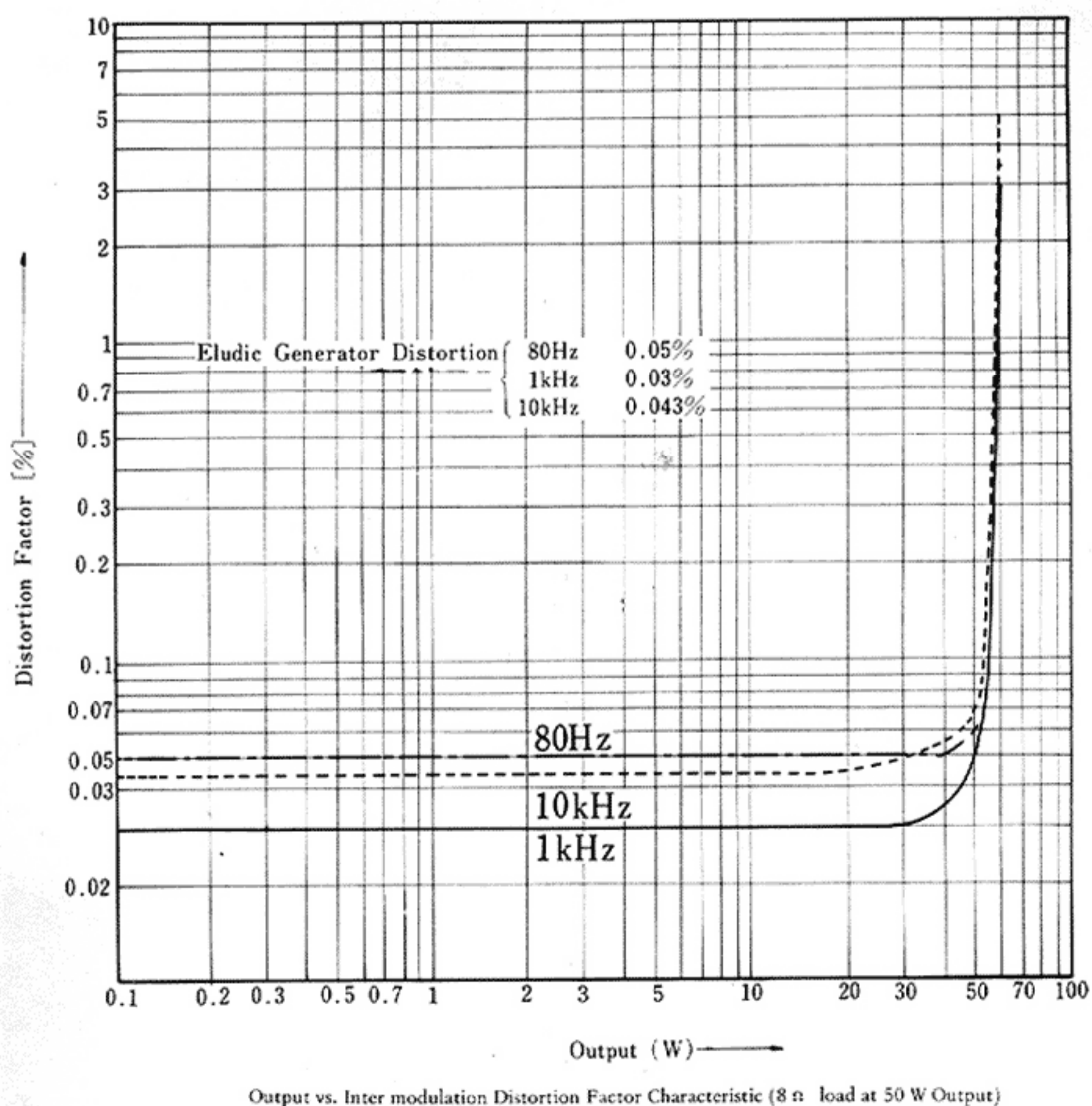
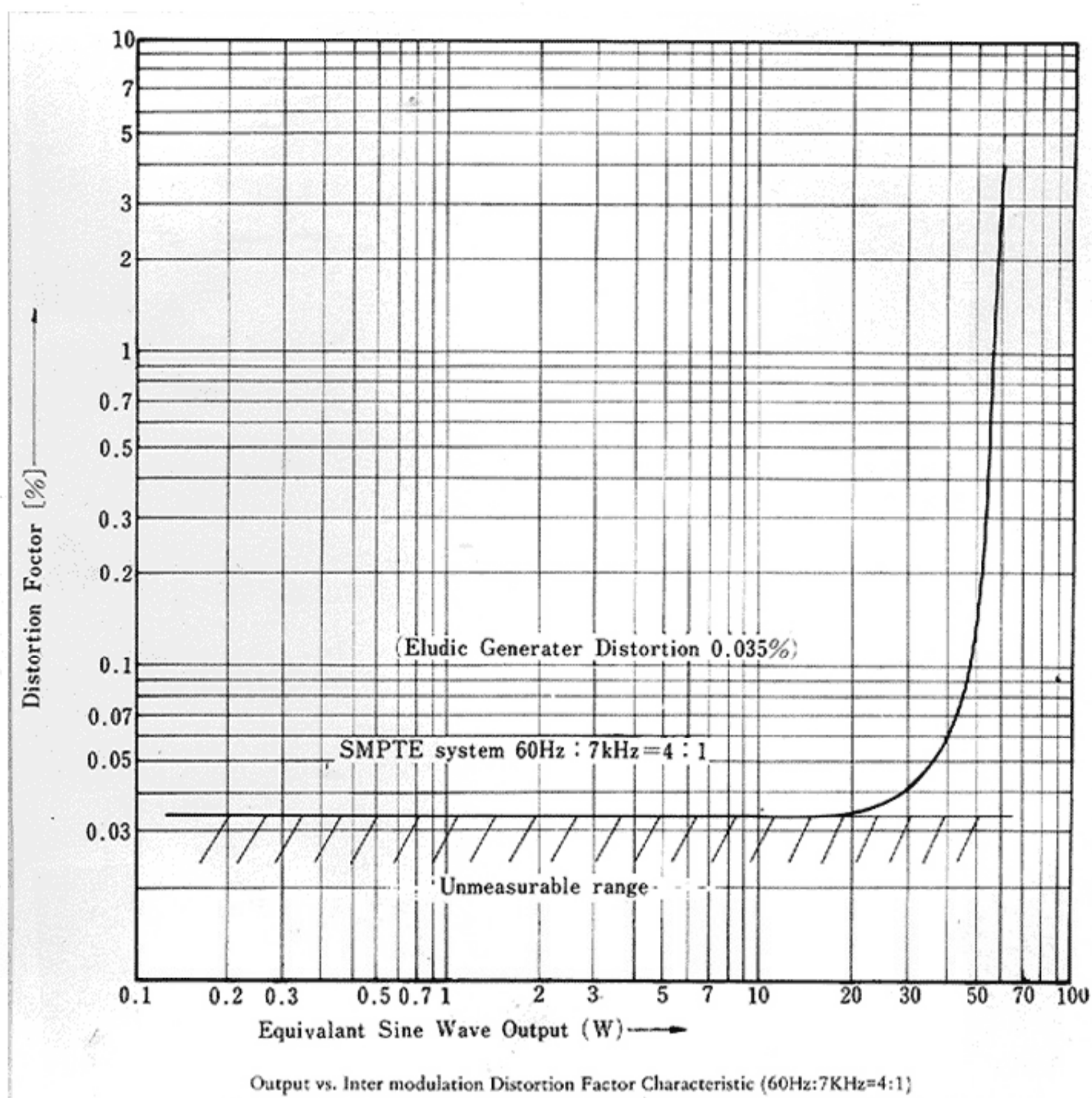

FEATURES

Minimum distortion from low to high power output:

An amplifier should have a low distortion factor even when the sound volume is either large or small. For this purpose, Model MCM-105E/5111 uses a Darlington complementary SEPP-OTL circuit in the output circuit. Also, a 85-volt power voltage is applied to improve the distortion characteristic. At 50 + 50 watt output, the harmonic distortion (see NOTE 1) is only less than 0.07% and the intermodulation distortion (see NOTE 2) that affects the clarity of sound is only less than 0.17%. At an output of 100 mW, both harmonic and intermodulation distortions are less than 0.05%. Thus, Model MCM-105E/5111 has a superb distortion characteristic at low output as well as at high output, maintaining the superior tone quality even with the sound volume decreased to a minimum for personal enjoyment.

NOTE: 1. The input-output characteristic of an amplifier is not linear, necessarily having some non-linear factor. Therefore, when one frequency is applied to an amplifier, frequencies of an integer times the original frequency are generated. Signals of these newly generated frequencies produce harmonic distortion.

2. When two or more frequencies are applied mixed into an amplifier, frequencies of sums and differences of the original frequencies and their harmonics are generated. Signals of these frequencies produce intermodulation distortion.



Damping factor switch:

Some of the currently prevailing bookshelf-type speaker systems are overdamping because their enclosures are small in volume, with a resultant large air-suspension effect. If a transistor amplifier having a low internal impedance and a large damping factor is connected to such bookshelf speaker systems or those speaker systems which are designed for use with a vacuum-tube amplifier, the bass generally becomes harsh, disabling the reproduction of mellow sound. With Model MCM-105E/5111, the above effect can be alleviated and more enjoyable sound reproduced, by setting the damping factor switch to a smaller value position. Also, this switch permits the reproduction of more crisp or mellow sound to suit the acoustic condition of the listening room. The efficient switch selects a desired damping factor in three steps: 50, 5 and 0.5.

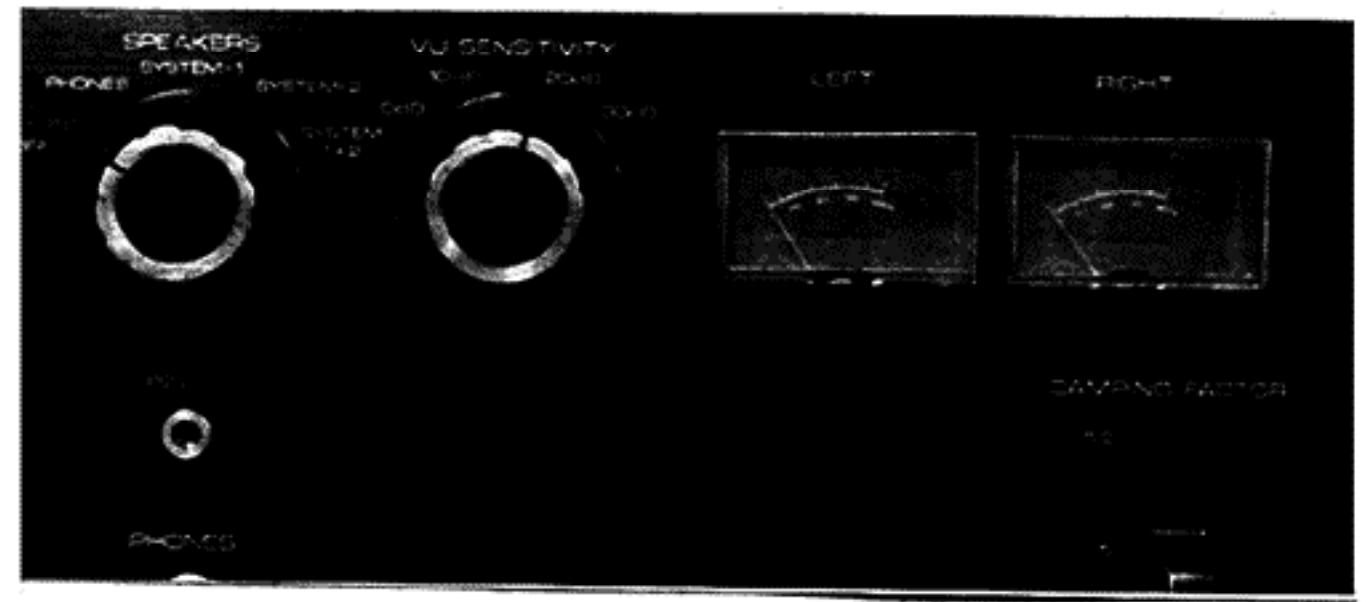

High-sensitivity VU meters (with sensitivity selector):

Model MCM-105E/5111 is equipped with separate VU meters for left and right channels, together with a meter sensitivity selector. Each VU meter is factory-adjusted to indicate 0 dB when the amplifier output through an 8-ohm load is 50 watts. With the sensitivity selector set to the 10, 20 or 30 dB position, the 0-dB indication on the VU meter signifies a 5-watt, 0.5-watt or 50 milliwatt output. Thus the VU meters clearly indicate the output level of the power amplifier.

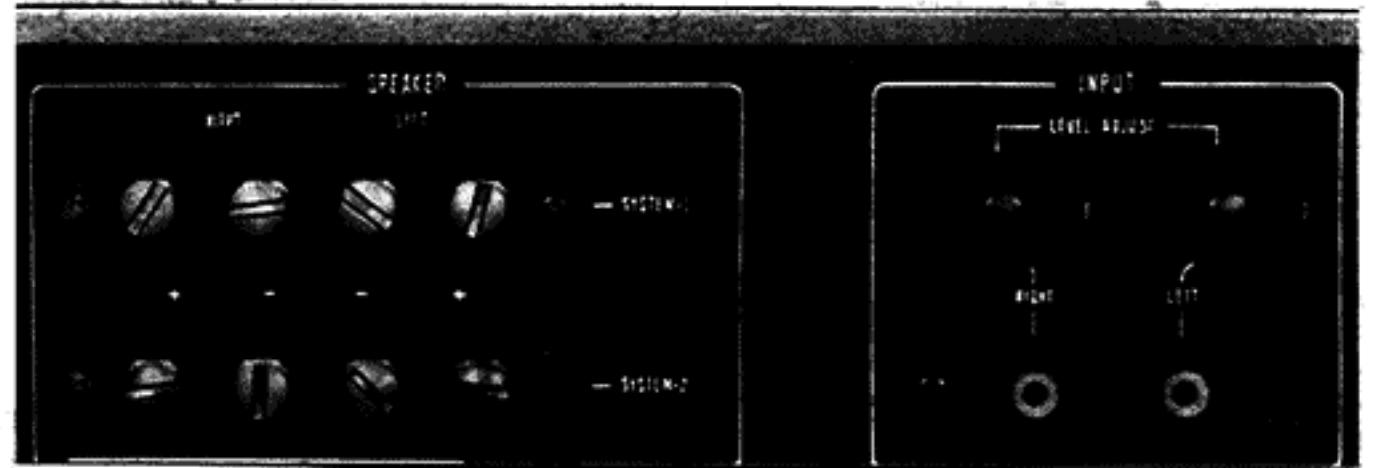

Two pairs of speaker systems connectable:

Two rows of speaker terminals are provided on the rear to permit the connection of two separate pairs of stereo speaker systems. By installing one pair in a room and the other pair in another room, and operating the speaker selector knob on the front, stereo sound is enjoyable in either one, or both of the two rooms. These two separate rows of speaker terminals are also conveniently used for comparatively testing stereo speaker systems.

Speaker protective circuit:

When the power switch of a stereo system is turned on, the speaker cone often shakes largely and emits noise; sometimes damaging the speaker. The circuitry of Model MCM-105E/5111 is so designed that a pause is given before the speakers get on when the power switch is turned on, and after the speakers are off the power switch is to be turned off. When turning on the power switch, set the speaker selector knob to the PHONES position, keep the knob there for a few seconds, and then turn the knob to the SYSTEM-1, SYSTEM-2 or SYSTEM 1+2 position desired. Thus the speaker systems are always protected from the possible damage as-above.

Automatically resetting protective circuit:

When an undue load is applied to Model MCM-105E/5111 because of a shorted speaker terminal or some other causes, the protective circuit incorporated operates to interrupt power from the output stage, protecting the transistors and other components in the power amplifier. When the cause is eliminated, the protective circuit automatically resets to resume the normal operation.

Input levels adjustable:

A semi-fixed adjustable resistor is provided to allow free adjustment of the input level of each channel. These level controls are especially effective when composing a multi-channel amplifier system.

Minimum residual noise and hum:

As the power supply of Model MCM-105E/5111 includes a ripple filter circuit, a DC power with least ripples is supplied to the driver stage.

This results in extremely low residual noise and hum, assuring the reproduction of crystal-clear stereo sound even when Model MCM-105E/5111 is operated at small sound volume in the very quiet room.

SPECIFICATIONS

| | |
|-----------------------|--|
| Total Dynamic Power | :140W(70W + 70W) IHF 8 100W(50W + 50W) IHF 4 |
| Continuous Power | :100W(50W + 50W) IHF 4, 8 |
| THD at Rated Output | :0.07% at 1KHz. |
| IM at Rated Power | :0.15% (60Hz : 7KHz = 4 : 1) |
| Power Bandwidth | :20 - 30,000Hz 0.5dB |
| Frequency Response | :18Hz - 45KHz 0.5dB. |
| Subsonic Filter | :18Hz, 45KHz -12dB/oct. |
| Signal to Noise Ratio | :110dB |
| Input Impedance | :120K |
| Input Sensitivity | :0.8V |
| Damping Factor: | :0.5, 5, 50 Selectable at 8Ω |
| Speaker Selector | :1, 2, 1+2 |
| VU Meter Sensitivity | :0, 10, 20, 30db |
| Protector Circuit | Automatically resetting |
| Power Source | :AC100V, 120V, 220V, 240V Selectable 50, 60Hz |
| Power Consumption | :190W. |
| Dimension | :5-7/16"(H), 8-1/2"(W), 12-5/8"(D) |
| Weight | :16.5 lbs. |

Rear Connections of the MCM-105E/5111

Speaker System Placed on the right side, facing the listener

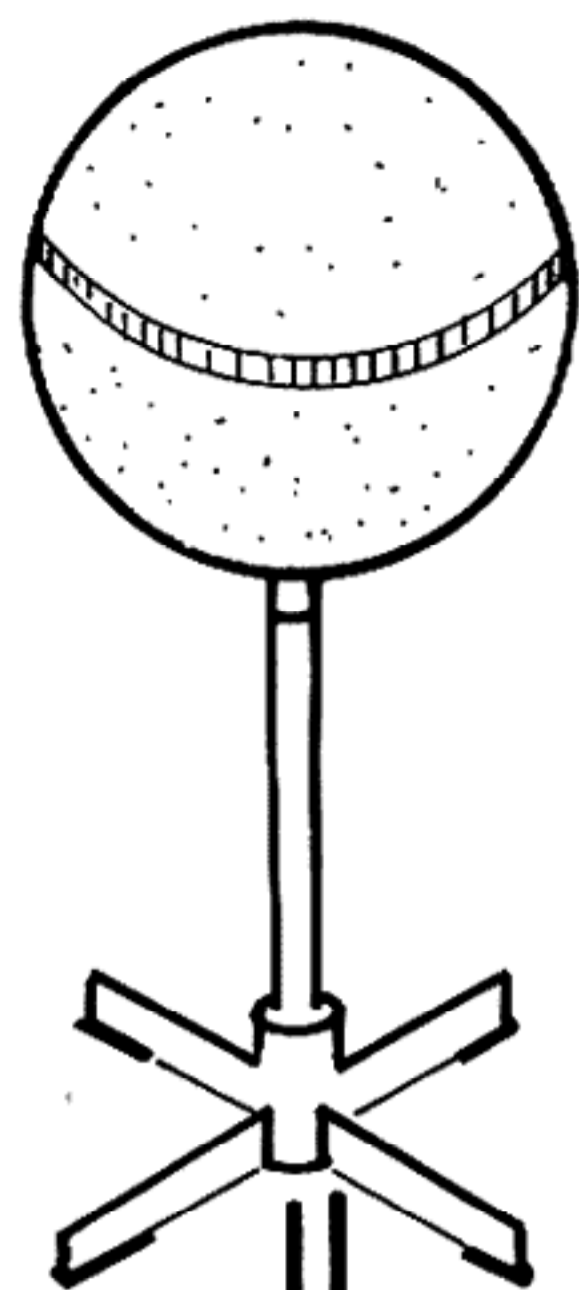

Speaker System Placed on the left side, facing the listener

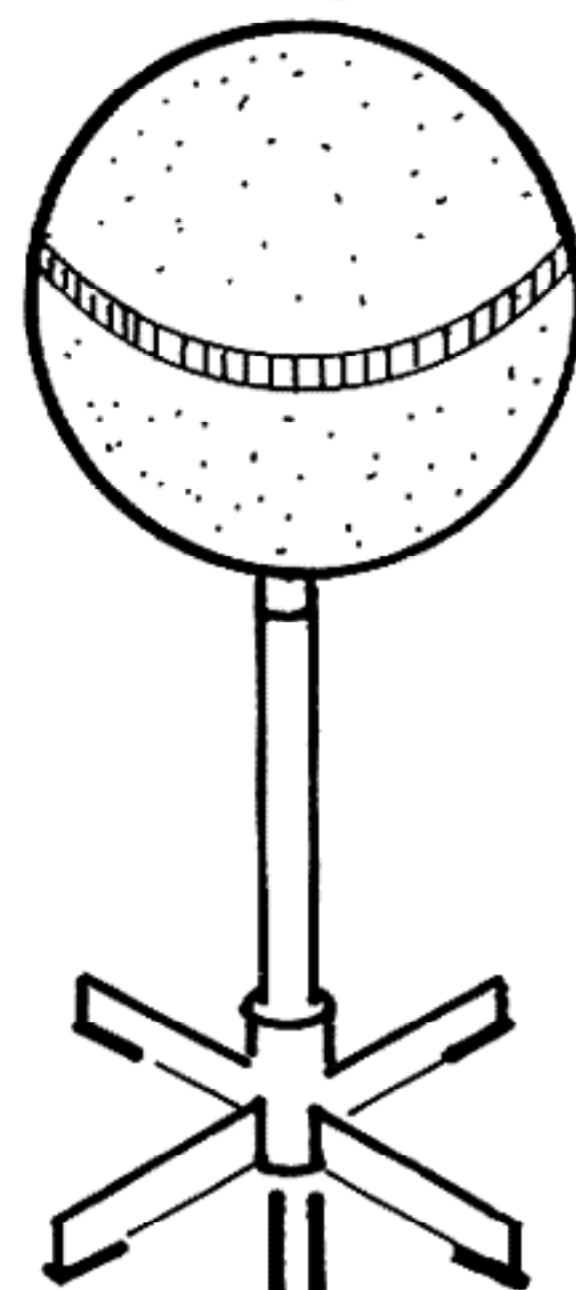

(Example: JVC MCP-105E/5110 Pre Amp.)

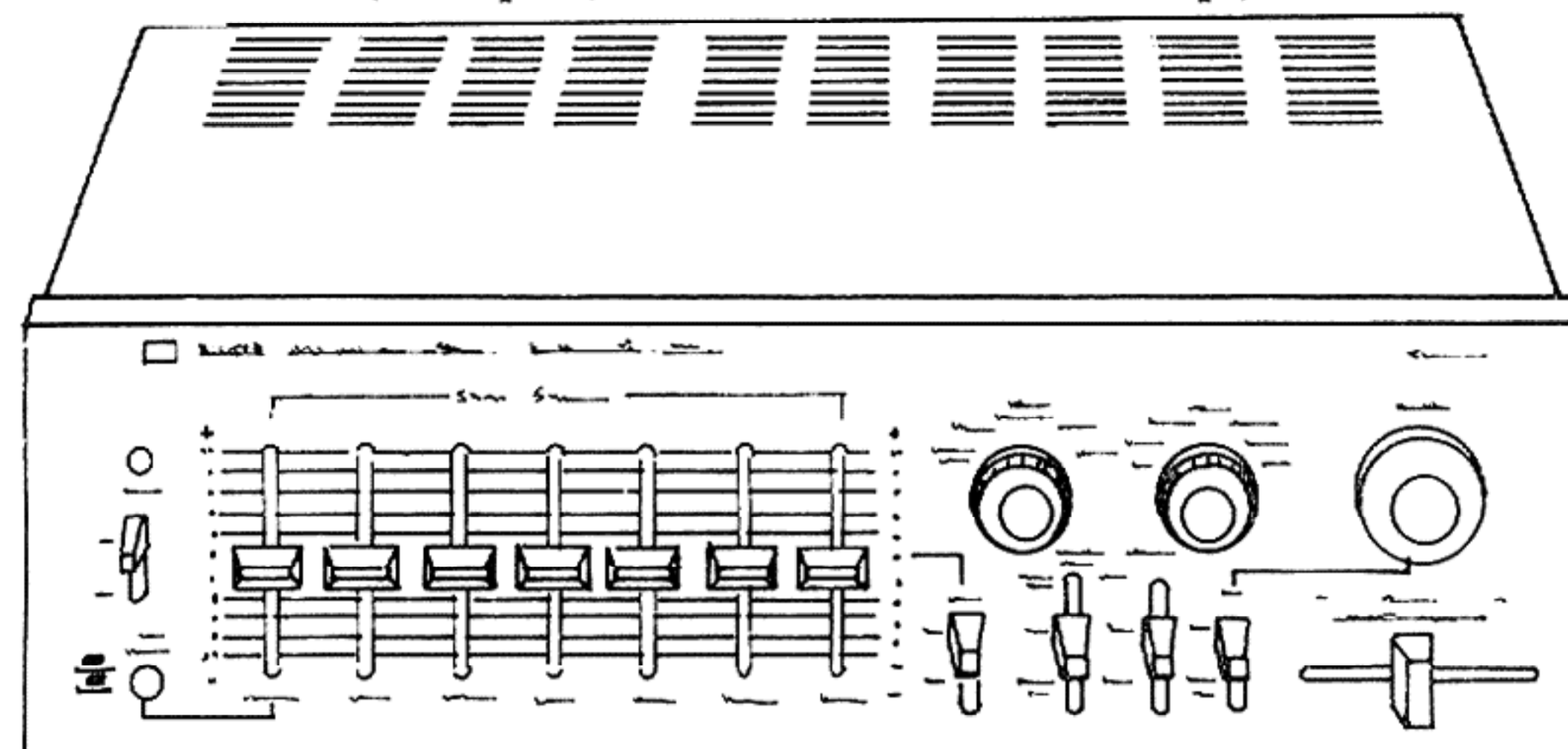

Rear Panel of JVC MCP-105E/5110 Pre-Amp.

Rear Panel of MCM-105E/5111

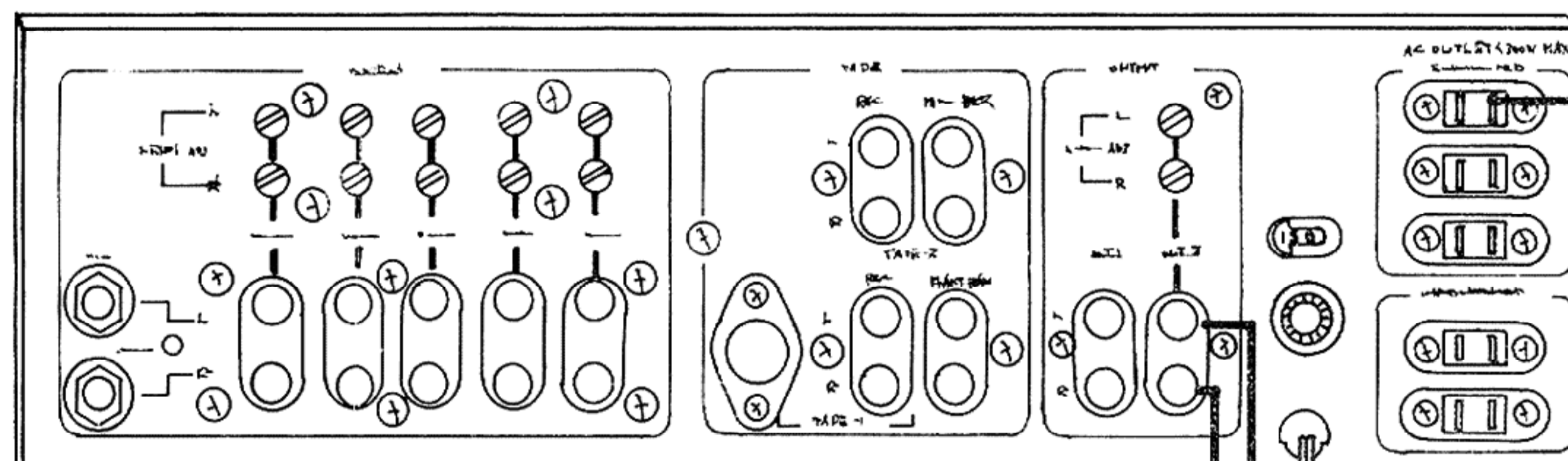
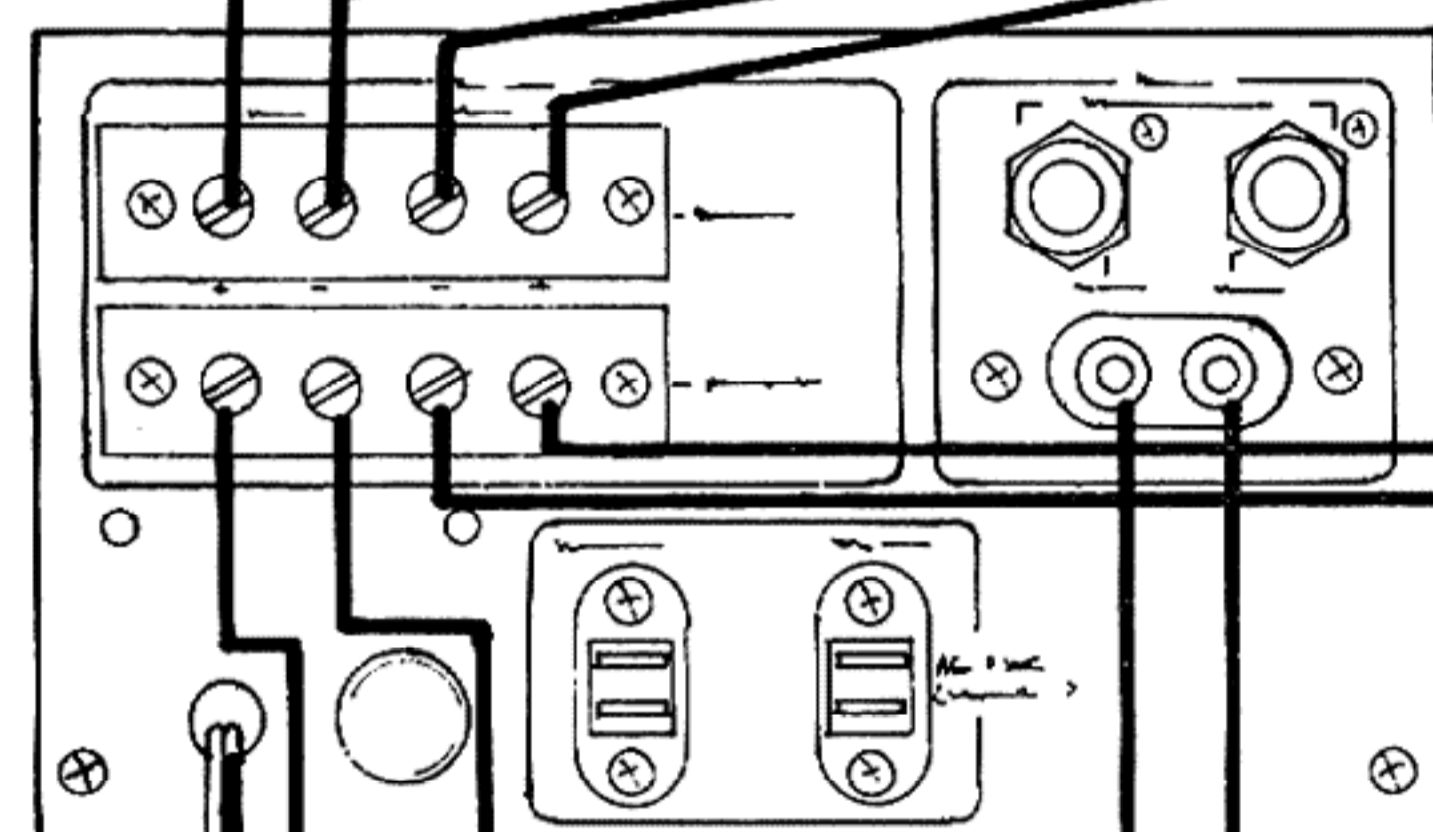

AC Outlet

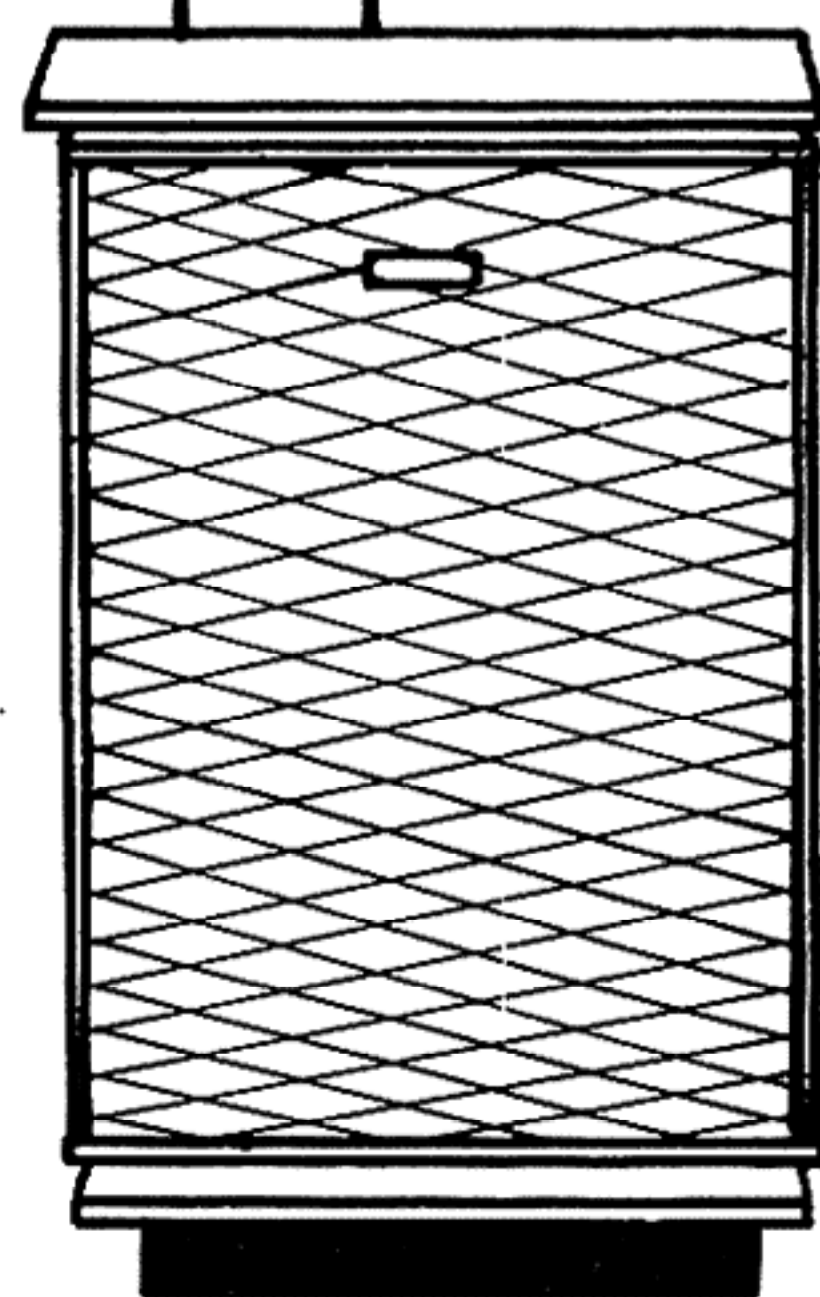

Speaker System Placed on the right side, facing the listener

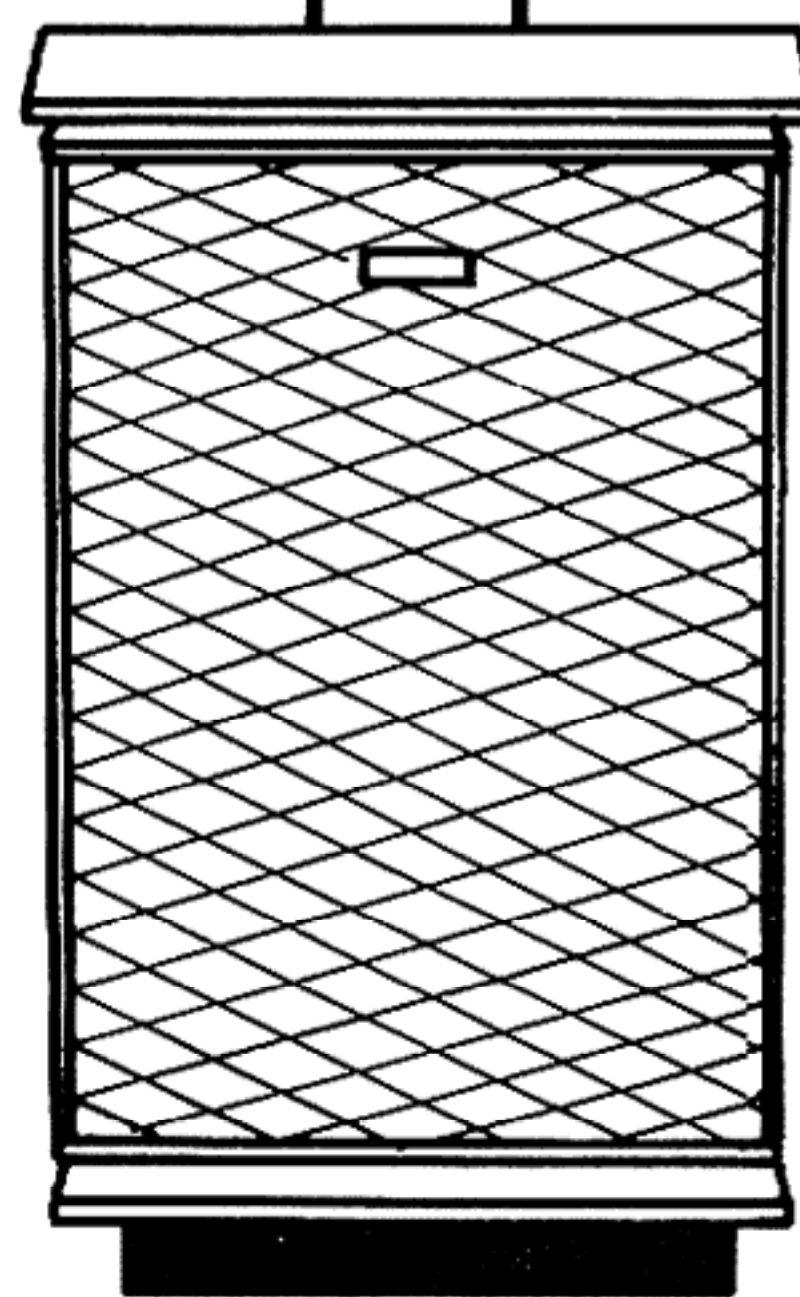

Speaker System Placed on the left side, facing the listener

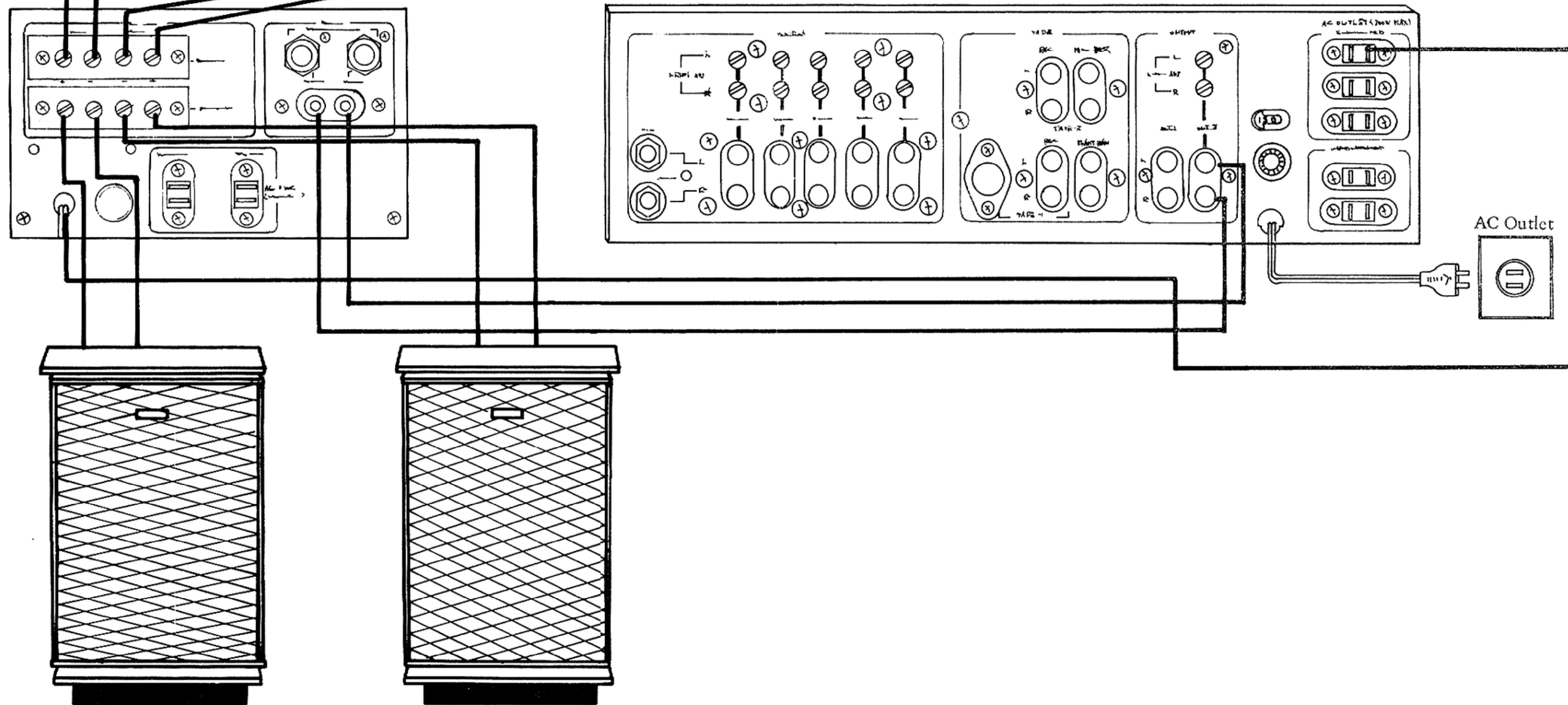

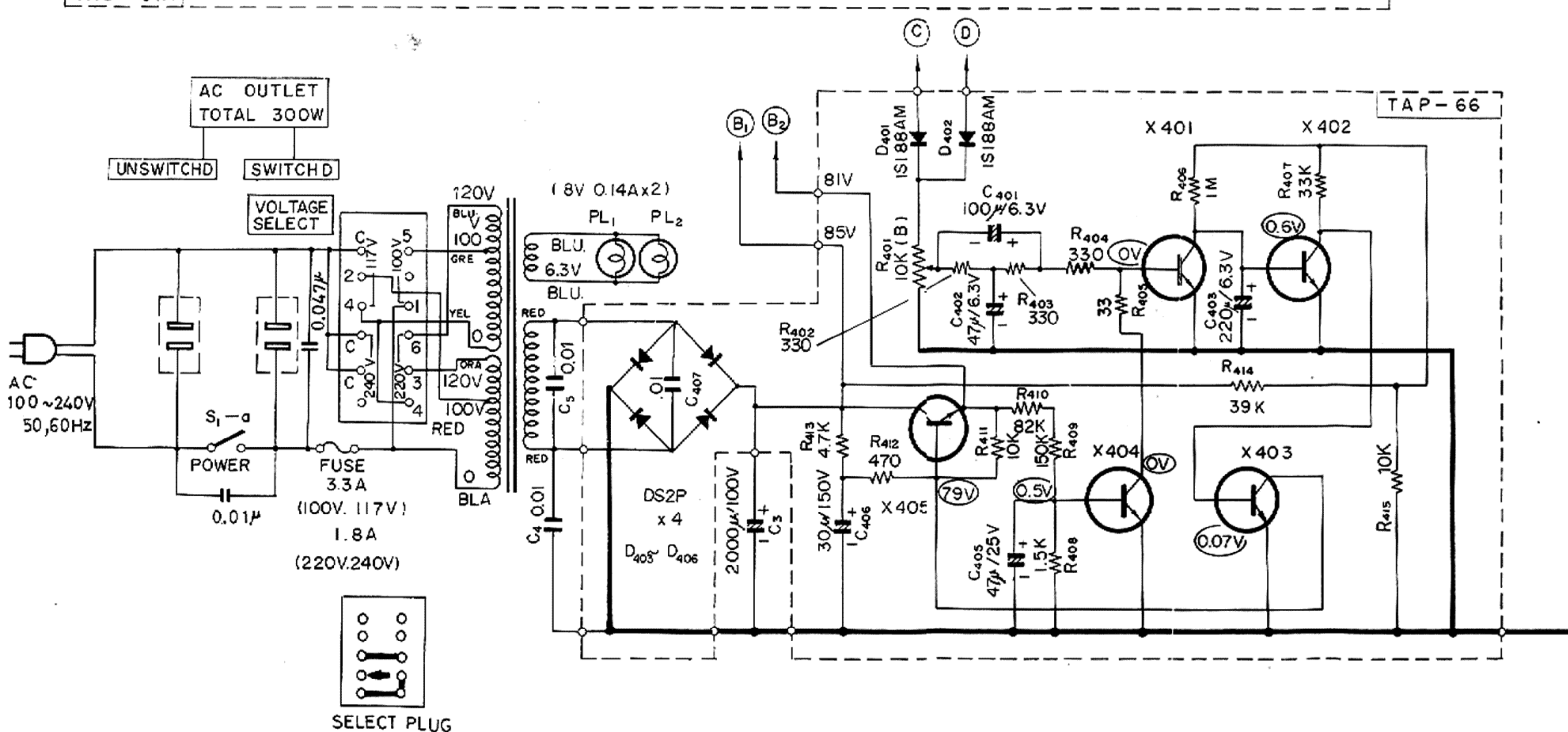
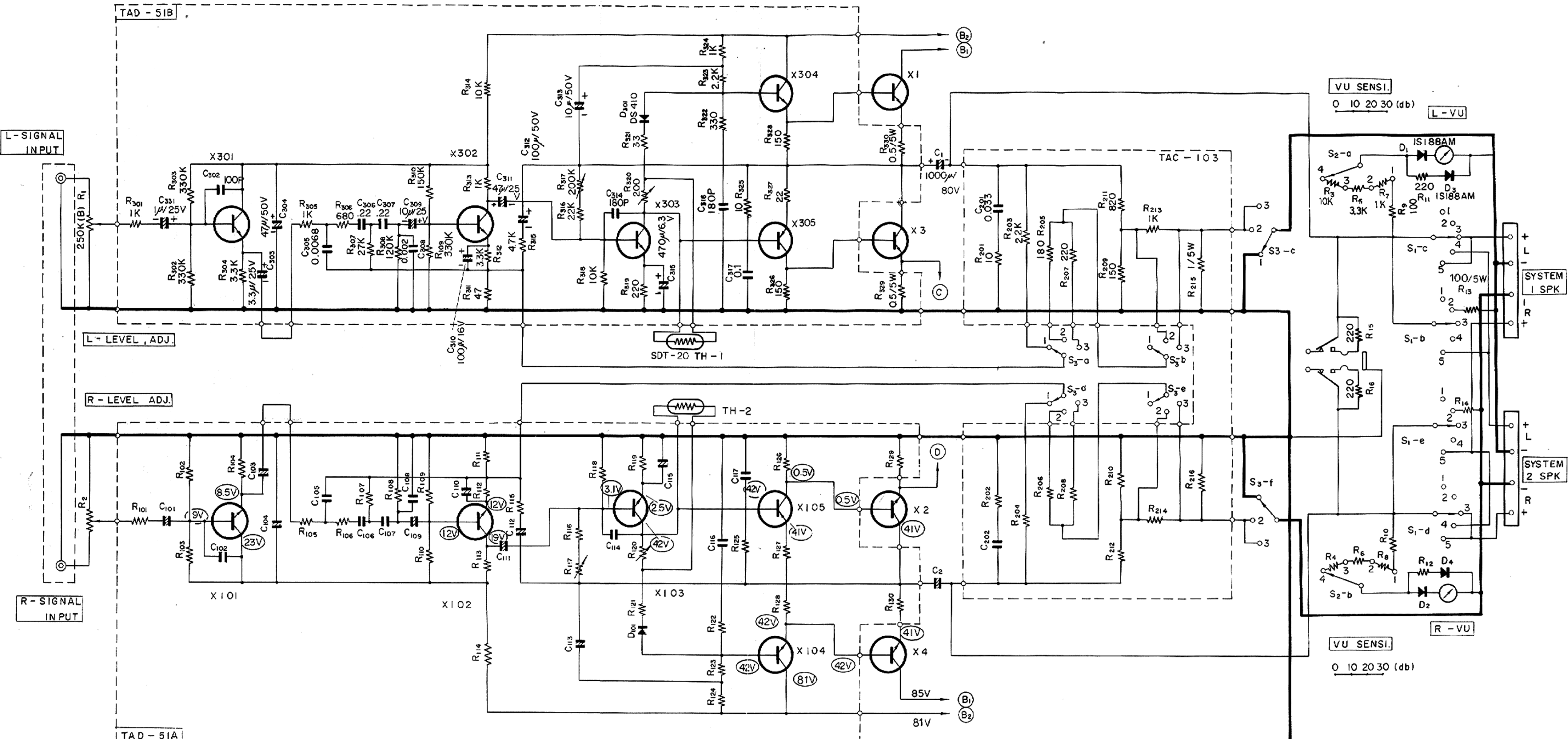

- | | | | |
|--------------------------|---------------|---|-----------|
| S ₁ SP切换 | 1. OFF | X ₁₀₁ ~ X ₁₀₂ , X ₃₀₁ ~ X ₃₀₂ | 2SC458LGC |
| (a~e) | 2. H. PHONE | X ₄₀₁ ~ X ₄₀₂ , X ₄₀₄ | 2SC458LC |
| | 3. SYSTEM 1 | X ₁₀₃ ~ X ₁₀₄ , X ₃₀₃ ~ X ₃₀₄ | 2SC484Y |
| | 4. SYSTEM 2 | X ₄₀₅ | 2SC484Y |
| | 5. SYSTEM 1+2 | X ₁₀₅ , X ₃₀₅ | 2SA537A |
| S ₂ VU.SENSI. | 1. 30 db | X ₄₀₃ | 2SC497 |
| (a~b) | 2. 20 db | X ₁ ~ X ₄ | 2SD203 |
| | 3. 10 db | | |
| | 4. 0 db | | |
| S ₃ DF. CONT. | 1. DF 50 | | |
| (a~f) | 2. DF 5 | | |
| | 3. DF 0.5 | | |

指定ナキ抵抗ハ 1/2 Wトスル

JVC
NIVICO

 **NIVICO**
VICTOR COMPANY OF JAPAN, LIMITED

PRINTED IN JAPAN E30580-21

This document was created with Win2PDF available at <http://www.win2pdf.com>.
The unregistered version of Win2PDF is for evaluation or non-commercial use only.
This page will not be added after purchasing Win2PDF.